

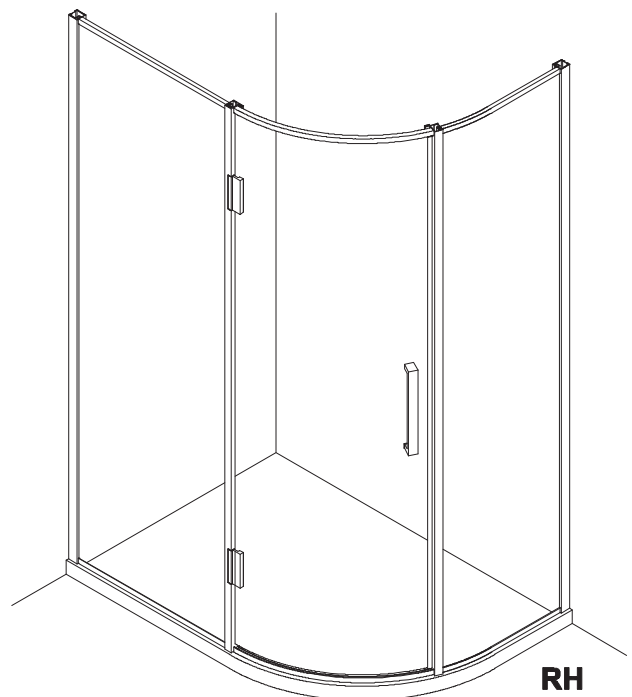

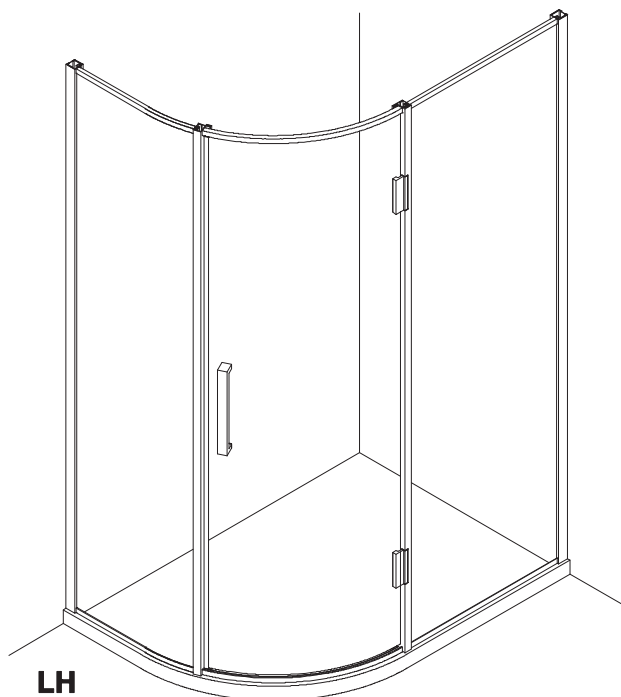

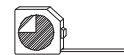

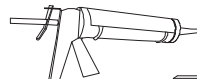

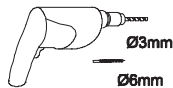
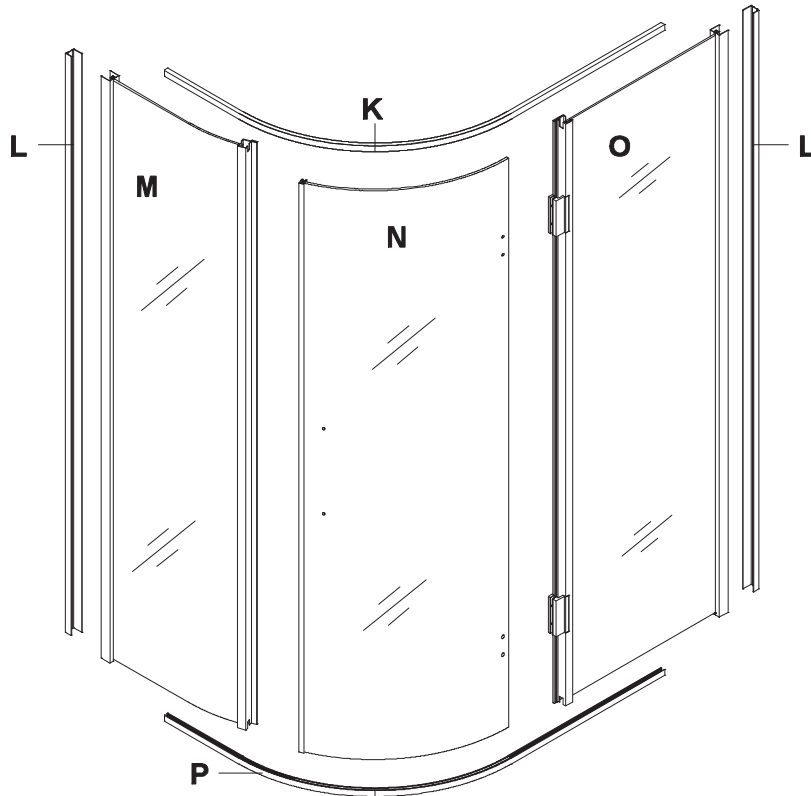

## Vetri Offset Quadrant Door Installation Instructions

- Prior to installation check that all fittings have been supplied.
- The tray should be installed by a competent person. The tray should be level, the walls should be tiled down to the tray, and the horizontal joint between the tiles and tray must be sealed with silicone sealant to ensure water-tightness.
- Handle with care. Impacts can damage both the glass and the frame.
- Please check for any hidden pipes or cables before drilling holes in the wall.
- The success of the installation and operation is, of course, dependant on the squareness, alignment and construction of the walls to which the enclosure is fixed. If the walls are significantly out of true we recommend dry lining the walls to ensure they are both vertical and at 90 ° to each other.
- The wall fixings supplied may not be suitable for your installation. You may need to source alternatives depending on the construction of the wall you are fixing to.

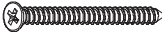
### Tools Required:



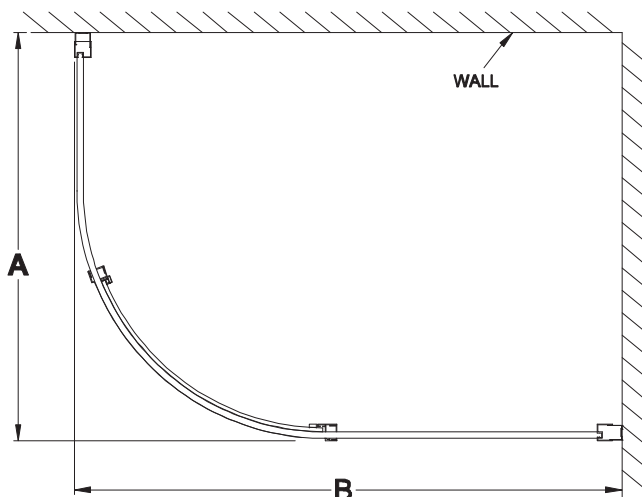

<b>A</b>		<b>8x</b>	<b>F</b>		<b>4x</b>
<b>B</b>		<b>8x</b>	<b>G</b>		<b>4x</b>
<b>C</b>		<b>8x</b>	<b>H</b>		<b>1x</b>
<b>D</b>		<b>8x</b>	<b>I</b>		<b>1x</b>
<b>E</b>		<b>8x</b>	<b>J</b>		<b>1x</b>

**BEFORE INSTALLATION:**

**ADJUSTMENT RANGE**

PRODUCT	A (mm)	B (mm)
1200 x 800 Offset Quadrant Door	760~780	1160~1180
1200 x 900 Offset Quadrant Door	860~880	1160~1180

